

Technical Characteristics

		PR 6000 SD
A	Inside body length	3.30 m
B	Overall length – door closed	4.75 m
C	Overall length – door open	5.73 m
D	Inside body width	1.35 m
E	Overall width with folded flap	2.27 m
F	Overall width with unfolded flap	2.92 m
G	Inside body height	1.26 m
H	Inside body length – door open	4.29 m
I	Overall height chute folded up (hydraulic/fixed axle)	2.00/2.33 m

- Standard
- Option

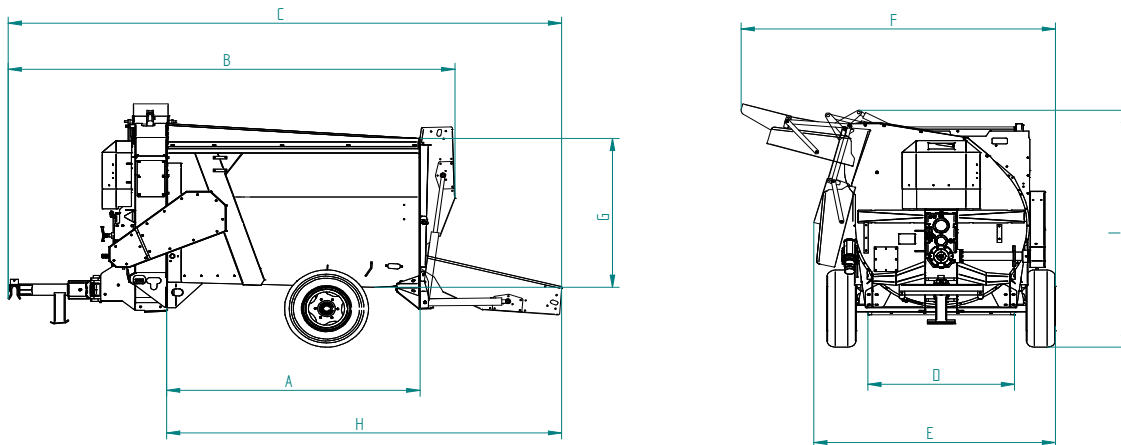

Equipment complies with safety standards.

We reserve the right to change our equipment and its characteristics at any time.